

# User Manual – Instructions of Use

## Micropipettes SG System for human embryo/oocyte manipulation in vitro

Revision: 03-2020

These glass and plastic disposable micropipettes are intended for manipulation of human embryos and oocytes In Vitro Fertilisation (IVF). They are sterile, non-toxic, made of borosilicate glass or plastic (PVC, PLA) and have well-defined internal diameters. The packaging is made so that the capillaries are manifold protected against mechanical damage and specially protected against biological contamination and loss of sterility. Colour labelling of pipette diameters permits the user to ensure the employment of the proper diameter pipette. The capillaries are sterile, MEA tested and have a valid EC Certification.

**CE** 2265

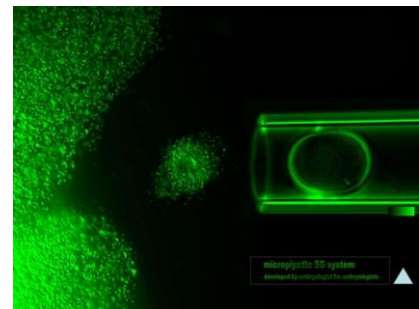

**Warning: DO NOT USE IF THE OUTER COVER IS DAMAGED (EN 865-5, art. 4.6., par. 1).**

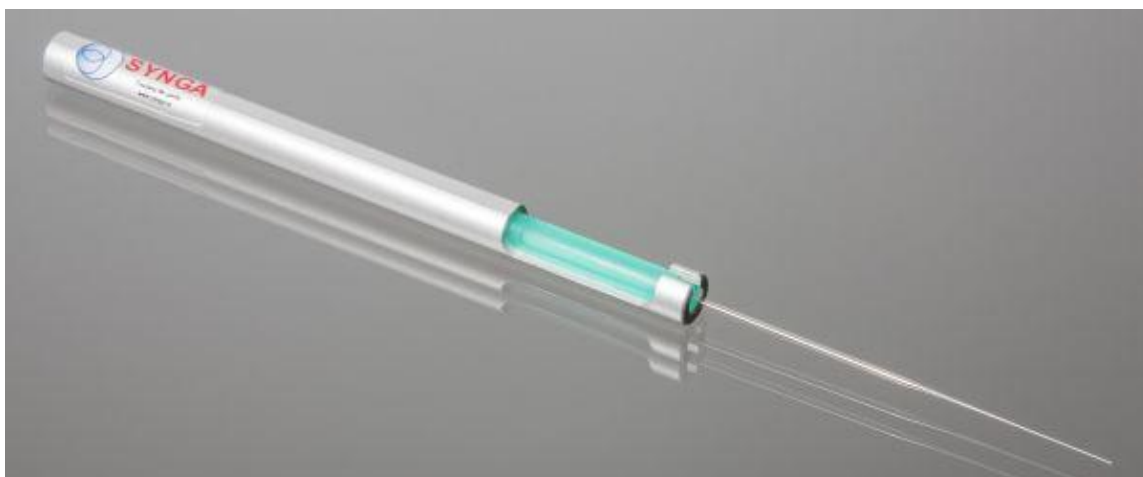
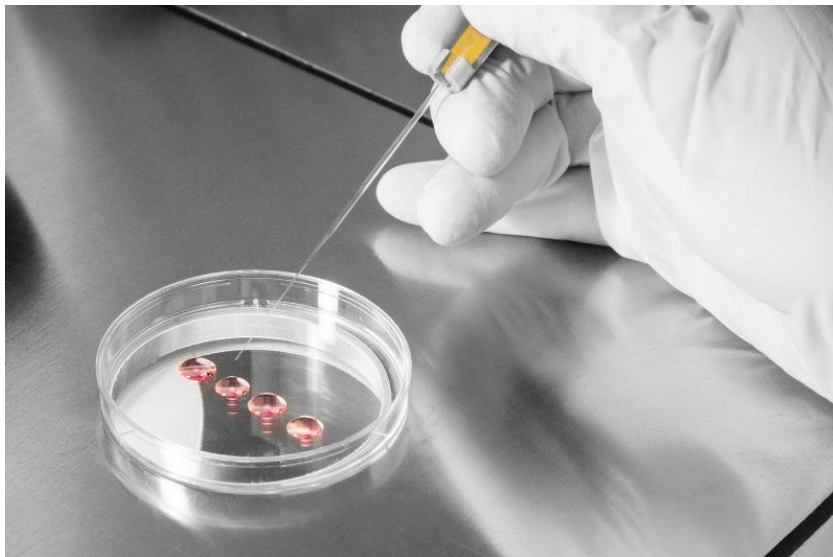

## Recommended procedure for removing the pipettes from their protective cover: important steps to preserve sterility and maintain inner diameter identification

### Step 1:

Open the transport tube. Each tube contains 10 straws and each straw contains a pipette. They are all oriented the same way, which means, that the functional tip is at the same end in all straws. Slowly turn the tube upside down and let the straws gently drop into a storage container. Thus they will be facing up with the part that is to be cut off when opening the straw.

It is recommended that you store your straws containing pipettes in the storage part of your SG Cutter. The SG System micropipettes will then be ready to use without disturbing your working area. This cutter combines the storage and cutting functions and is supposed to be attached to a wall of your laminar flow box.



### Comment:

Both glass and plastic capillary pipettes are placed in a straw so that the broader part of the pipette is on the upper side (by the wider sealed end) while the working narrow part is by the narrower end of the straw.

The diameter of the pipette can be recognised by the colour of the straw. Each diameter is to be used with a bulb of the same colour (green, yellow or blue). Deeper colour is for Soft bulbs, lighter colour is for the ExtraSoft ones.

To make sure, which end of the straw to cut off, you may wish to look at the straw against a strong light source. Through the straw you can see the pipette and make sure you cut above the wide end, not the narrow tip.

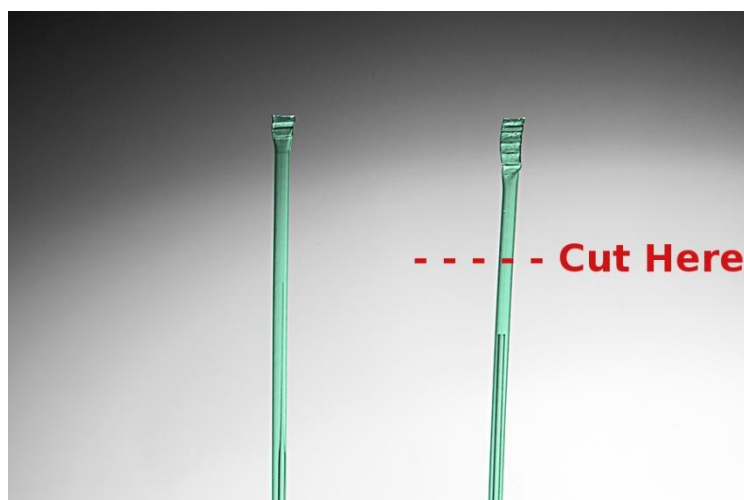

**Step 2:**

**(Preferably to be conducted in the protected area of an IVF cabinet):**

Cut the straw just below the wide end closure. The best tool for this operation is the SG Cutter specifically made for use with SG System micropipettes. With this cutter micropipettes can be conveniently stored and their cover straws opened using just one hand. Additionally, there is no risk of cut waste separating from the straw and falling into the IVF cabinet. Depending on the version, this cutter can be attached to the right or left side wall of the IVF cabinet (for the SG-007-CUT R and the SG-007-CUT L respectively).

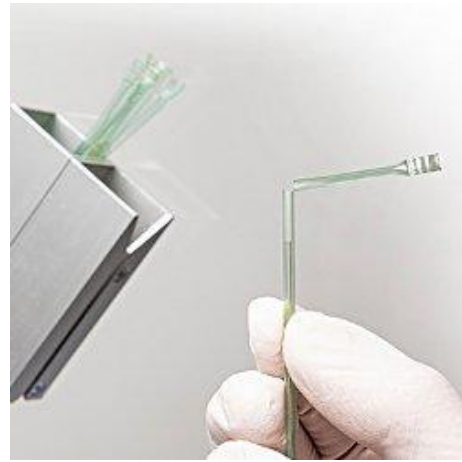
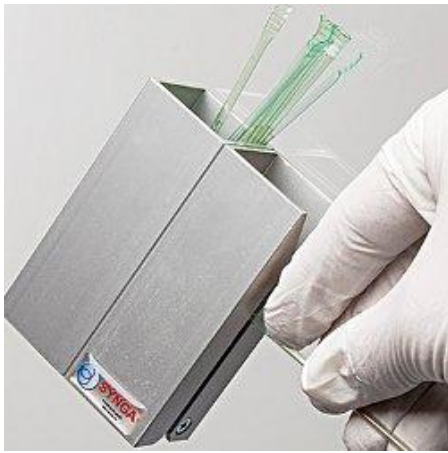

The cutting procedure is shown in the picture above. First, pull the straw down through the gap in the SG Cutter. It is important to hold the straw close to the cutter to protect the capillary inside. Bend the cut-off part on the top of the straw.

**Step 3:**

Turn the straw upside-down and carefully slip the pipette out of the straw. Hold the pipette by its broader end and immediately attach the appropriately coloured bulb. The pipette is now ready for sterile use with a permanent colour identification of the diameter.

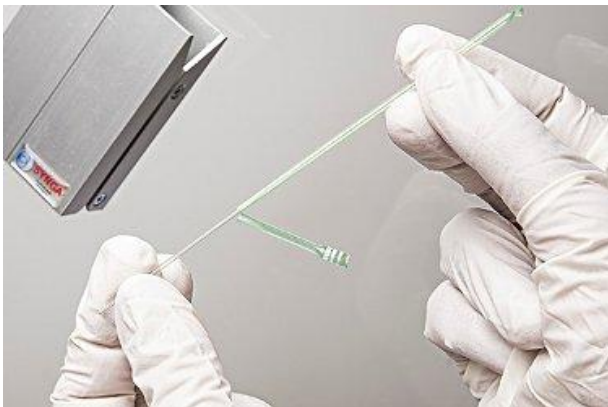

**Warning:**

The narrow working part of the pipette must not come in contact with non-sterile surfaces or solutions!

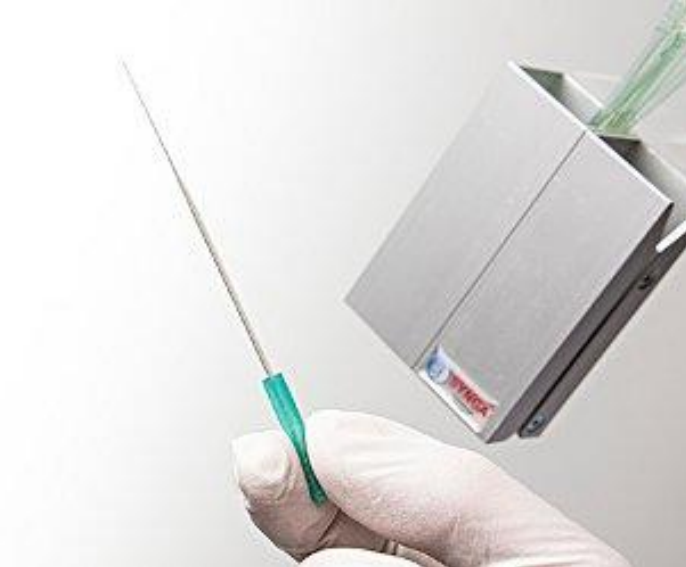

Pipette is now ready for use, with a penholder or without it. Notice the right cutter mounted on the right wall.

**Synga premounted**

If you are using our premounted pipettes, you don't need a cutter. Pipettes are supplied with a bulb already attached to the capillary. Synga premounted pipettes are supplied in a box containing for blister sheet, each sheet with five pipettes. To open the packaging, simply peel the blister paper. Premounted pipettes are easier to use, but because of their packaging they are bulkier.



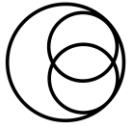

**SYNGA**  
TOUCHING LIFE GENTLY

**Notes:**

Please note, that not all pipettes of the same diameter have identical length. There is the following tolerance of lengths:

Total length of a pipette is  $\pm 5$  mm, which means, the difference could be up to 1 cm. Length of functional part of the pipette is  $\pm 3$  mm, which means the difference could be up to 6mm. All the lengths in between are complying with Synga standards and certificates.

Please note, that denudation pipettes have sharp edges of the functional part (sharp opening). Sometimes they appear 'chipped'. However be assured that it does not have any effect on the cleanliness of the inner part of the pipette. Our quality control is very strict regarding any bits of glass inside the capillary. If you happen to see some chips, they may be on the outer side of the pipette and have no impact on the safe and clean usage of it.

In manipulation and blastocyst pipettes this does not happen, as they have blunt openings.

***The cutters order numbers:***

*SG-007-CUT-R*

*SG Cutter. Storage of unopened sealed pipettes and the cutter tool to be attached to the **right side** wall of the IVF cabinet*

*SG-007-CUT-L*

*SG Cutter. Storage of unopened sealed pipettes and the cutter tool to be attached to the **left side** wall of the IVF cabinet*

## Labelling Explanation

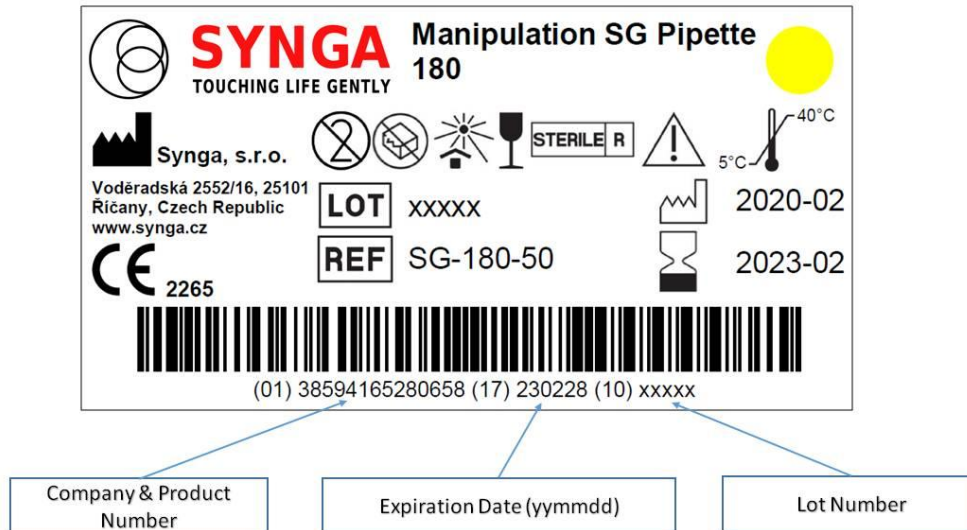
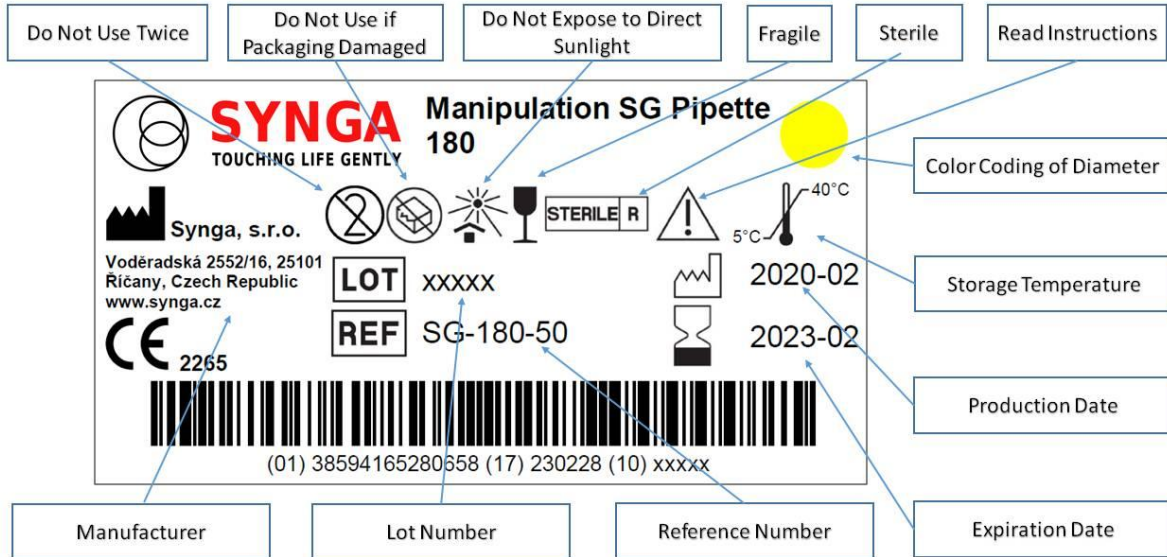

## Pipette models – intended use

(ID - internal diameter)

### 1. Denudation pipette: (*sharp opening*)

Is intended for **mechanical cleaning of corona cells** (after enzymatic displacement of cumular cells)

Other possible use:

- blastomer fixation (embryonic cells) during PGD
- manipulation of embryos of other species

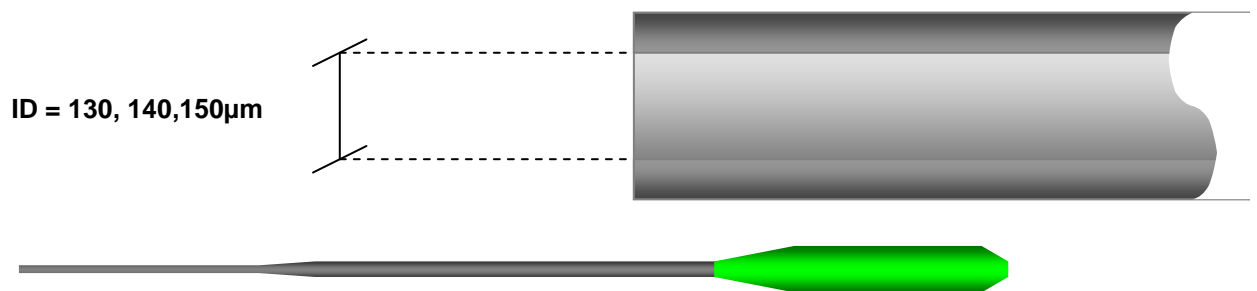

### 2. Manipulation pipette: (*blunt opening*)

Is intended for **manipulation of early stage (day 1 – 4) human embryos**

May also be use as embryo carrier during vitrification.

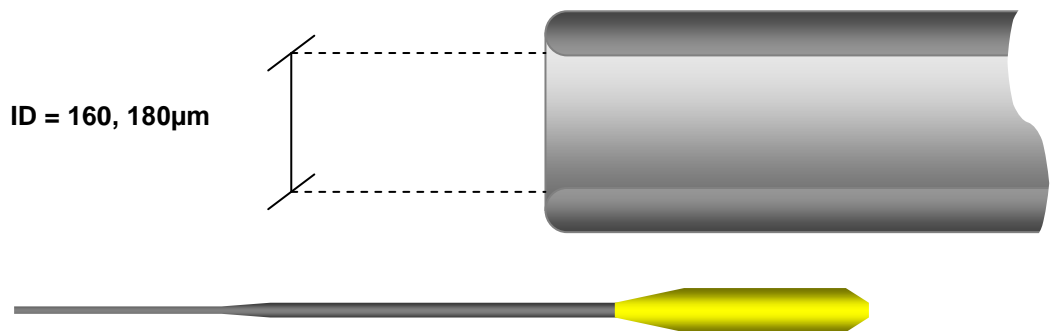

### 3. Manipulation (blastocyst) pipette: (*blunt opening*)

Is intended for **manipulation of human embryos in the stage of expanded resp. hatching blastocyst**

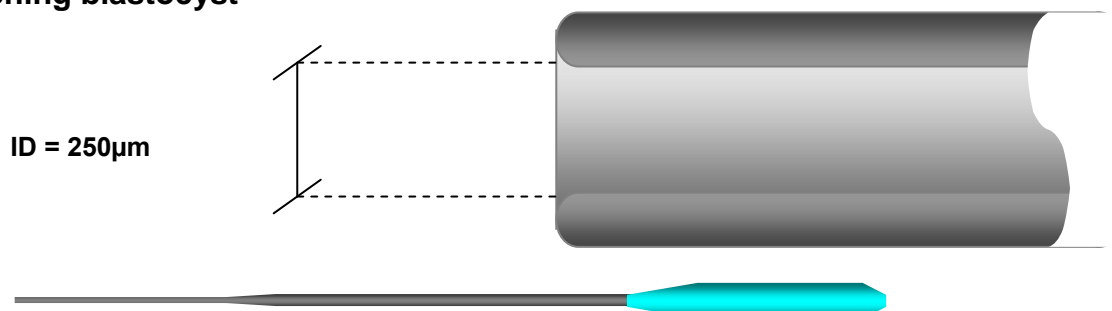

## How to choose the right pipette

The pipettes are made with different inner diameter (and corresponding shape of the edge as described on the previous page) and different functional part length, see parameter w in the picture below.

The longer the length w is, the more objects the embryologist can take in and the work is faster and easier in general. However, also, the longer the length w, the more is the pipette flexible and some embryologists may complain it is flexible (“vibrating” or “bending”) too much. Therefore we make **Long** and **Short** version of our pipettes so that each user can choose the right length.

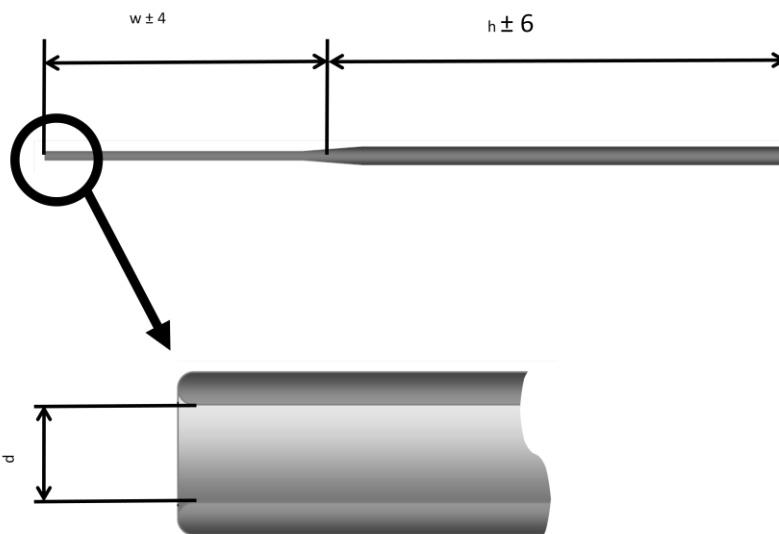

Currently (2017) manufactured intended lengths w are as in the table below. Please mind that the length may however vary in a tolerance of few millimetres.

		<i>edge</i>	<i>w [mm]</i>
Denudation	SG120S	Sharp	14
Denudation	SG130S	Sharp	14
Denudation	SG130L	Sharp	30
Denudation	SG140S	Sharp	14
Denudation	SG140L	Sharp	30
Denudation	SG150S	Sharp	14
Denudation	SG150L	Sharp	30
Denudation	SG160S	Sharp	14
Denudation	SG160L	Sharp	30
Manipulation	SG180S	Blunt	14
Manipulation	SG180L	Blunt	30
Blastocyst	SG250S	Blunt	14
Blastocyst	SG250L	Blunt	30
Blastocyst	SG300S	Blunt	14



## How to choose the right bulb

The bulbs are blister packed by 5 pieces, 4 sheets in one pack. Altogether 20 bulbs in each unit. They are made in different colours so that user can use them as colour coding for the diameter of the attached pipette.

**130 µm – Red**  
**140 µm – Green**  
**180 µm – Yellow**  
**250 µm – Blue**

They are made in 2 different shapes: the **classic** is thicker and the **VI** is thinner and very soft.

For **classic** bulb shape the appropriate pen holder is:



SG-021-20SG



SG Pen Holder C SG-021-4

The classic shape is additionally made in 2 different Stiffness':  
**Soft** and even softer **XtraSoft**

For **VI** bulb shape the appropriate pen holder is:



SG-VI-20XY



SG Pen Holder VI SG-021-3



## **SG CUTTER blade replacement**

Blade replacement is provided by distributors for a fee. When the cutter is no longer sharp enough, please contact your local Synga distributor who, following receipt of your SG Cutter, will install a new blade and return it to you shortly. Distributors set the applicable charge.

## **Disposal**

Used Synga pipettes should be stored in a dedicated receptacle and disposed of as glass or plastic waste respectably. The cover should be disposed of as plastic waste, according to applicable laws and regulations.

## **Medical Device Vigilance System**

To increase the protection and safety of patients and reduce the possibility of re-occurrence of incidents, any incident or undesired events have to be reported according to EU commission directive 62/2015 MEDDEV 2.12/1 rev., art. 2, par 1. Using the appropriate report form – Manufacturer's Incident Report (MEDDEV 2.12/1 rev 6).

In case the product is to be resold to other parties the seller / distributor is obliged to keep verifiable documentation on end users and sold lots to comply with the Medical Devices Vigilance System.

## **Information, suggestions and comments**

To share comments or suggestions regarding the Synga system, please send them (including identification and lot numbers of the relevant product) to Synga, s.r.o.:

SYNGA s.r.o.  
Želivská 1955  
251 01 Říčany u Prahy  
Fax: +420 731416187  
E-mail: [synga@synga.cz](mailto:synga@synga.cz)

Thank you for choosing Synga, s.r.o. products for your minimally-invasive, high-precision work with living cells.

---